

Naprave za vuču i dizanje tereta

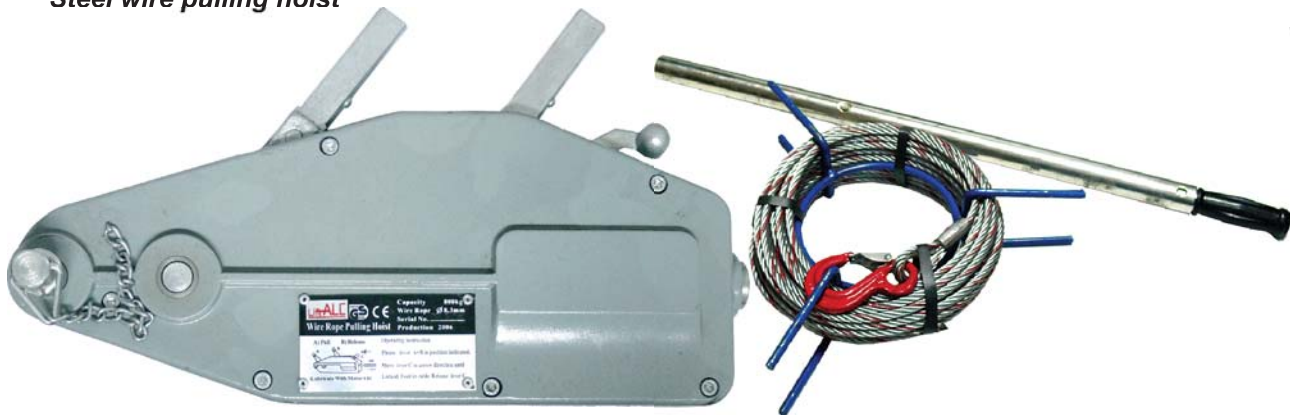

1. Naprava vučna Tirfor Steel wire pulling hoist



Primjereno za vuču, nije za dizanje. Vrlo lagana. Izrađena iz kvalitetnog aluminija, opremljena s 20 m specijalnog čeličnog užeta i priborom. Nabavlja se u tri različite veličine: 800 kg, 1600 kg i 3200 kg. S dodatno učvršćenim koluturom možemo im povećati vučnu silu.

Suitable for pulling not lifting. Low weight wire rope pulling hoist made of aluminium. Wire rope pulling hoist can be delivered in several versions: 800 kg, 1600 kg and 3200 kg. With extra fixed pulley we can extend their powers.

Tip	Nosivost	Jačina povlačenja ručke	Dužina ručke	Promjer užeta	Težina bez užeta	Težina užeta
Type	Capacity	Lever strenght	Lever lenght	Wire rope diameter	Weight without wire rope	Wire rope weight
	kg	daN	mm	mm	kg	kg/m
W08	800	24	800	8,4	7,0	0,29
W16	1600	30	790/1190	11,5	14,0	0,53
W32	3200	50	790/1190	16,0	21,0	1,0

2. Dizalica ručna s ručicom Lever hoist Lift-ALC



Dizalica za profesionalnu upotrebu. Primjerena za dizanje različitih tereta i artikala. Osnovna dizalica ima 1,5 m lanca, nosivu kuku i kuku za učvršćivanje. Nabavlja se u 5 različitih nosivosti i to: 0.75t, 1t, 2t, 3t i 6t.

Chain hoist is for professional use, for lifting different kind of weights and articles. Base chain hoist is with 1,5 m lift, load hook and bottom hook. We can deliver five different types: 0.75t, 1t, 1.5t, 3t and 6t.

Nosivost	Broj lanaca	Dimenzija lanca	Podizanje pri jednom zamahu ručke	Jačina povlačenja ručke	Težina dizalice
Capacity	No. of chain strands	Chain diameter d x t	Lift at one pull	Pulling strenght	Neto weight
kg		mm	mm	daN	kg
750	1	6 x 18 (T)	18	14	7,0
1500	1	8 x 24 (T)	15	22	11,2
3000	1	10 x 30 (T)	16	34	21,0
6000	2	10 x 30 (T)	8	35	30,0

3. Dizalica s lancem, profesionalna

Chain block, professional



Nosivost Capacity	Broj lanaca No. of chain strands	Dimenzija lanca Chain diameter d x t	Dužina lanca za 3m dizanja Wire rope length at 3 m lift	Duž. lanca za dizanje 1m tereta Chain at 1m lift	Pomak tereta za 1m lanca za diz. Weight without wire rope	Sila potezanja lanca Pulling strength	Težina dizalice Neto weight
kg		mm	m	m	mm	daN	kg
500	1	6 x 18	3,2	28	35	26	9,0
1000	1	6 x 18	3,3	42	23	36	11,2
2000	1	8 x 24	3,4	54	18	54	18,0
2000	2	6 x 18	6,3	84	12	37	15,3
3000	1	10 x 30	3,5	83	12	52	28,0
3000	2	8 x 24	6,6	108	9	41	24,7
5000	2	10 x 30	6,6	165	6	44	38,7
8000	4	10 x 30	13,5	329	3	38	69,2
10000	4	10 x 30	13,5	329	3	46	69,2
15000	8	10 x 30	27,8	659	1	2x35	157,4
20000	8	10 x 30	27,8	659	1	2x46	157,4

Dizalica za profesionalnu upotrebu. Primjerena za dizanje različitih tereta i artikala. Osnovna dizalica ima 3 m lanca, nosivu kuku i kuku za učvršćivanje. Nabavlja se u 5 različitih nosivosti i to: 0.5t, 1t, 2t, 3t i 5t.

Chain hoist is for professional use, for lifting different kind of weights and articles. Base chain hoist is with 3 m lift, load hook and bottom hook. We can deliver five different types: 0.5t, 1t, 2t, 3t and 5t.

4. Električna dizalica US

Electric hoist US

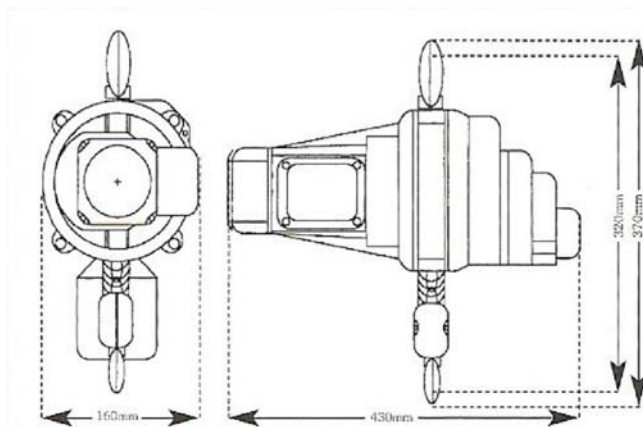

Profesionalna dizalica za sve vrste dizanja. Treba ju imati u svakom servisu. Ona je za sve poduzetnike.

The Pro jobbing hoist for all hoisting jobs. Should not be missing in any service van. For civil contractors.

Nosivost Capacity	Kataloški broj Catalog no.	Standard. dizanje Std. lift	Brzina Speed	Izlaz Output	Napon Power	Pad lanca Chain falls	Mjere Dimensions				Težina Weight
t		m	m/min	Watt	Volt		A	B	C	D	kg
0,5	US 901	Neobavezno Optional	6	1200	230	1	320	370	430	160	16

5. Mini električna dizalica PA200A, PA400A

Mini electrical hoist PA200A, PA400A



jednostruko uže



dvostruko uže - preko koloture

Model Model	Nosivost jednostuka/dvostruka Rated load single/double	Voltaža Rated Volt	Ulazna snaga Input power	Brzina dizanja Lifting speed	Visina dizanja Lifting height	Dizalica u kutiji Quantity	Kutija Packing size	Težina Weight
	kg	V	W	m/min	m	kom/pcs	cm	kg
PA200A	100/200	230	510	10	11,5	1	36x22,5x14	11
PA250A	125/250	230	510	10	11,5	1	36x22,5x14	11
PA300A	150/300	230	600	10	11,5	1	36x22,5x14	12
PA400A	200/400	230	980	10	11,5	1	39,5x24x15	16,5
PA 500A	250/500	230	1020	10	11,5	1	39,5x24x15	17



Moguća isporuka dizalica nosivosti 600, 800 i 1000 kg
Possible delivery of electrical hoists with capacity 600, 800 and 100 kg

6. Kočnica elektrtomagnetna KEM za dizalicu VEDA

Equipment for Electric chain hoist

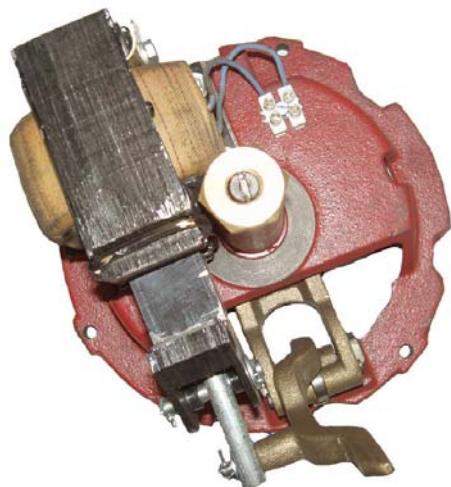

Rezervni dijelovi:

- Elektromagnet



- Svitak



- Obloga - feroda



- Među ploča



- Pritisna ploča



KOLICA DIZALICE RUČNA Hand trolleys LiftALC

7. Kolica dizalice, ručna GCT Plain Trolley GCT

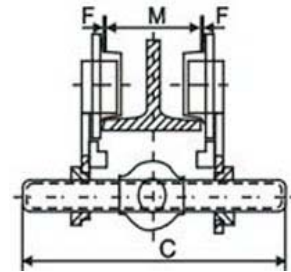
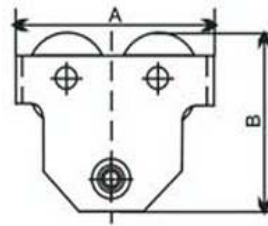
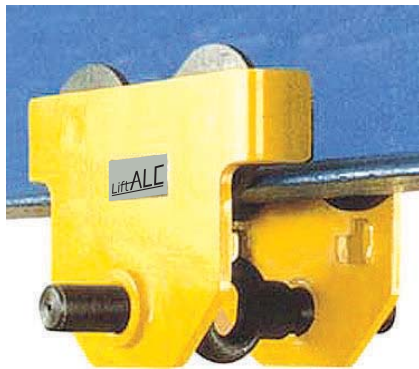

Model Model	Nosivost Capacity	Testna nosivost Test load	Minimalni radijus Min. radius of curve	Dimenzije Dimensions				Podesiva širina I profila (nosača) Adjustable Beam Width M	Težina Weight		Ambalaža Carton			
				A	B	C	F		kg	kg	cm	cm		
GCT-0.5	0,5	7,35	0,9	225	176,5	292	377	≈3	64-220	160-305	8,3	8,7	28,5x8,5x33,5	28,5x8,5x42
GCT-1	1	14,71	1,0	252	188	300	385	≈3	64-220	160-305	10,9	11,4	28,5x8,5x33,5	28,5x8,5x42
GCT-2	2	29,42	1,2	300	226	310	395	≈3	88-220	160-305	18,2	19	33,5x15x25	42x15x33
GCT-3	3	44,13	1,3	360	290	324	409	≈3	102-220	160-305	31,4	32,5	40x34x33	40x42x33
GCT-5	5	61,29	1,4	392	313	329	414	≈3	114-220	160-305	42,6	44	45x36x36	45x36x44

8. Kolica dizalice ručna GCL, s lančanicom za pomicanje Geared Trolley GCL

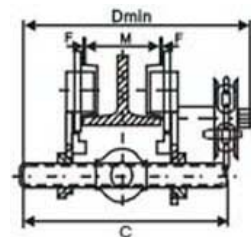
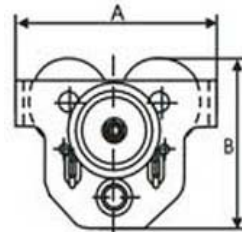
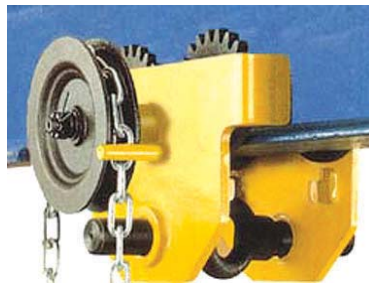

Model Model	Nosivost Capacity	Testna nosivost Test load	Visina dizanja Running height	Sila potezanja lanca za dizanje tereta Chain pull to lift full load	Minimalni radijus Min. radius of curve	Dimenzije Dimensions				Težina Weight		Ambalaža Carton				
						A	B	a	b	a _{Dmin}	b	F	a	b	a	b
GCL-0.5C	0,5	7,35	3	45	0,9	225	173	292	377	292.5	383	≈3	13.3	13.7	33x29x24.5	42x29x24.5
GCL-1C	1	14,71	3	80	1,0	252	188	300	385	302.5	393	≈3	15.9	16.4	33x29x24.5	42x29x24.5
GCL-2C	2	29,42	3	150	1,2	300	226	310	395	319.5	398	≈3	23.2	24	85.5x33x29	46x33x29
GCL-3C	3	44,13	3	120	1,3	360	290	324	409	354	425.5	≈3	37.7	38.8	39x38x35	46x38x35
GCL-5C	5	61,29	3	160	1,4	392	313	329	414	365	430.5	≈3	48.9	50.3	45.5x39x37	53x39x37

9. Naprava za vuču s kukama

Hand Puller with gear and hooks



Samo za vuču! Nije za podizanje!
Only for pulling! Not for lifting!

Model Model	Nosivost Capacity	Tip Type	Zupčanik Gear	Kuka Hook	Linija kabela Cable line	Veličina kabela Cable size	Teža Weight
						mm x m	kg
HPS-2H-1	1,0	-	1	2	1	4,5x1,68	2,10
HPS-2H-L2	2,0	Teški teret	1	2	2	4,5x1,78	2,25
HPD-2H-L2	2,0	Lagani teret	2	2	2	4,5x1,78	2,50
HPS-2H-H2	2,0	Teški teret	1	2	2	5,0x2,28	3,00
HPD-2H-H2	2,0	Teški teret	2	2	2	5,0x2,28	3,30
HPD-3H-H2	2,0	Teški teret	2	3	2	5,0x2,28	3,30
HPS-2H-L4	4,0	Lagani teret	1	2	2	5,0x2,28	4,75
HPD-2H-L4	4,0	Lagani teret	2	2	2	5,0x2,28	5,00
HPS-2H-H4	4,0	Teški teret	1	2	2	6,0x3,05	5,25
HPD-2H-H4	4,0	Teški teret	2	2	2	6,0x3,05	5,50
HPD-3H-H4	4,0	Teški teret	2	3	2	6,0x3,05	5,75
HPD-3H-2	2,0	Alum.	2	3	2	4,5x3,66	4,00
HPD-3H-4	4,0	Alum.	2	3	2	6,0x3,66	5,75

10. Vitlo ručno s čeličnim užetom ili s trakom

Hand winch with steel wire rope or strap



Samo za vuču! Nije za podizanje!
Only for pulling! Not for lifting!

Model Model	Nosivost Capacity	Veličina kabela Cable size	Zupčanik Gear	Br. kuka No. of hooks	Teža Weight
		lbs	mm		
		mm x ft	mm		
RL19-1201	1,0	4.5 x 10	JEDAN	2	1,90
RL19-1202	2,0	4.5 x 10	JEDAN	2	2,90
RL19-1203	2,0	5.0 x 10	JEDAN	2	3,10
RL19-1204	3,0	5.0 x 10	JEDAN	2	4,00
RL19-1205	4,0	5.6 x 10	JEDAN	2	4,95
RL19-1206	3,0	5.1 x 10	JEDAN	3	4,40
RL19-1207	4,0	6.0 x 10	JEDAN	3	5,40
RL19-1208	2,0	4.8 x 10	DVA	2	3,00

11. Dizalica mehanička samostojeća SJ/SJL Mechanical Steel Jack SJ/SJL

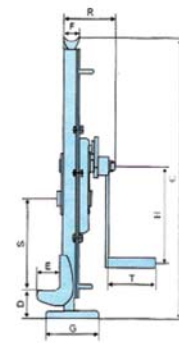

Model Model	Nosivost Capacity	Testna nosivost Test load	Ručica za dizanje tereta Hand shake to lift full load	Dimenzije Dimensions												Težina Weight	
				A	B	C	D	E	F	G	H	K	R	S	T		
	t	t	mm	mm	mm	mm	mm	mm	mm	mm	mm	mm	mm	mm	mm	mm	kg
SJ1,5	1,5	22	300	81	100	600-900	70-370	55	46	110	225	147	119	166	113	16	
SJ3,0	3,0	44,1	350	83	130	735-1090	70-425	60	45	138	249	170	140	235	128	20	
SJ5,0	5,0	73,5	400	108	140	730-1075	80-425	71	68	170	249	190	155	217	128	28	
SJ10,0	10,0	147,0	580	124	140	800-1190	100-490	86	76	170	300	252	185	187	250	46	
SJL5,0	5,0	73,5	400	108	180	730-1075	40-385	71	68	170	249	190	155	257	128	31	
SJL10,0	10,0	147,0	580	124	180	800-1190	40-430	86	76	170	300	252	185	247	250	51	

12. Vrtuljak s vijkom XL, za nošenje Bearing swivel XL



Model Model	Dopušteno opterećenje Safety Load Limit	Dimenzije Dimensions					Težina Weight
		A	B	C	D	E	
	t	mm	mm	mm	mm	mm	kg
XL-5	0,5	24	90	70	11	8	0,4
XL-10	1,0	29	113	82	13	12	0,6
XL-30	3,0	38	145	110	16	16	1,0
XL-50	5,0	42	165	125	18	16	1,5
XL-80	8,0	57	220	165	24	22	3,0
XL-130	13,0	62	275	195	26	24	4,3

13. Vrtuljak s okom AB, za nošenje Bearing swivel XL



Model Model	Dopušteno opterećenje Safety Load Limit	Dimenzije Dimensions					Težina Weight
		L	L1	L2	D	d	
	t	mm	mm	mm	mm	mm	kg
AB-5	5	305	120	92	78	38	8
AB-10	10	403	150	125	103	51	20

ELEMENTI ZA RUČNE DIZALICE

Components for chain block and lever hoist

14. Kuka za ručnu dizalicu, gornja

Chain hoist TOP hook



15. Kuka nosiva za ručnu dizalicu

Chain hoist BOTTOM hook



16. Kuka za ručnu dizalicu s ručkom, gornja

Lever hoist TOP hook



17. Kuka nosiva za ručnu dizalicu s ručkom

Lever hoist BOTTOM hook



18. Kolica ručna s tri kotača LSP20 Hand Cart LSP20

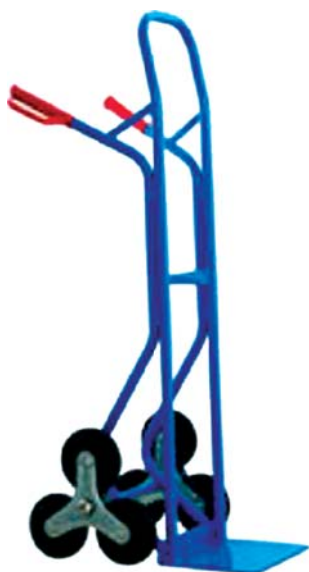

Model Type	Nosivost Capacity	Nutarnje mjere (d, v, š) External dimension (L, W, H)	Veličina kolica Deck size	Tip kotača Caster type	Veličina kotača Caster size
	kg	mm	mm		mm
LSP20	200	1300x460	300x220	Gumirani	160x40

19. Kolica za premještanje tereta FW025 Skates for load transport FW025



Model Type	Nosivost Capacity	Nosivi kotači Load wheels	Veličina kotača Wheel size	Veličina koturaljke Skate size	Težina Weight
	kg		mm	mm	kg
FW025	2500	2	ø86xø90	285x120x101	8,40

20. Kolica za premještanje tereta FY12 in FY06 Skates for load transport FY12 and FY06



Model Type	Nosivost Capacity	Nosivi kotači Load wheels	Veličina kotača Wheel size	Veličina koturaljke Skate size	Težina Weight
	kg		mm	mm	kg
FY06	6000	6	ø83x60	3247x250x107,5	20,50
FY12	12000	8	ø115x60	400x345x145	40

FY12

FY06

21. Kolica za premještanje tereta Fw02 in FW06 Skates for load transport FW02 and FW06

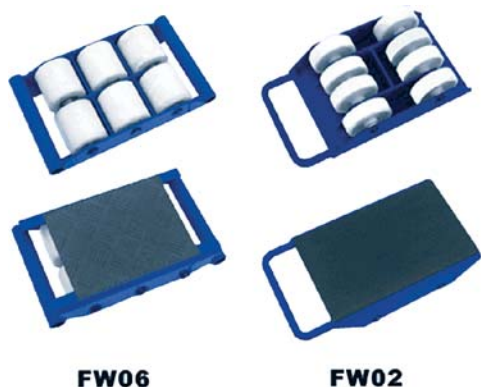

Model Type	Nosivost Capacity	Nosivi kotači Load wheels	Veličina kotača Wheel size	Veličina koturaljki Skate size	Težina Weight
	kg		mm	mm	kg
FW02	2000	8	ø100x42	408x220x118	8,4
FW06	6000	6	ø86x90	395x330x101	13,8

22. Kolica za premještanje ručna SFW03 Skates SFW03



Model Type	Nosivost Capacity	Nosivi kotači Load wheels	Veličina kotača Wheel size	Veličina koturaljke Skate size	Težina Weight
	kg		mm	mm	kg
SFW03	3000	4	ø86x90	305x231x108	14,4

23. Kolica ručna za premještanje teških tereta XY Skates for transport of heavy load XY



Model Model	Nosivost Capacity	Br.kotača No. of rollers	Dimenzija okretne ploče Dimensions of turnplate	Dužina ručke Podesiva dužina ručke Length of handle Adjusting length of lever	Veličina Overall size	Težina Weight
	t		mm	mm	mm	kg
X4+Y4	8	4	Ø 150	800	230x230x110	28
	8	4	140x120	300-1000	170x140x110	28
X8+Y8	16	8	C 160	1100	560x420x110	72
	16	8	200x160	400-1300	200x200x110	72
X12+Y12	24	12	Ø 180	1100	750x450x110	100
	24	12	220x180	400-1400	256x200x110	100
X16+Y16	32	16	Ø 200	1100	936x500x110	124
	32	16	240x200	400-1500	310x220x110	124
X18+Y18	36	18	Ø 200	1500	780x550x110	138
	36	18	280x200	400-1500	300x550x110	138