

VALJKASTI LANCI, EVROPSKI STANDARD

ROLLING CHAINS, EUROPEAN STANDARD

ISO 606 - 1982 (DIN8187) JEDNOREDNI

REZERVNI SPOJNI ELEMENTI / SPARE PARTS

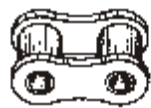

No.3
UNUTRAŠNJI ČLANAK
INNER LINK

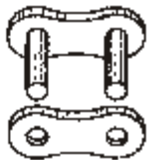

No.108
SPOLJNI ČLANAK
OUTER LINK



No.28
ČLANAK ZA
VEZU PRAV
CONNECTING LINK

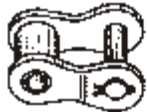

No.114
KRIVI ČLANAK
ZA VEZU
CRANKED LINK

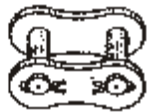

No.68
ČLANAK
ZA VEZU PRAV
CONNECTING LINK



No.32
DUPLI KRIVI ČLANAK
CRANKED LINK DOUBLE



No.32
SPOJNA OPRUGA
SPRING CLIP FASTENER

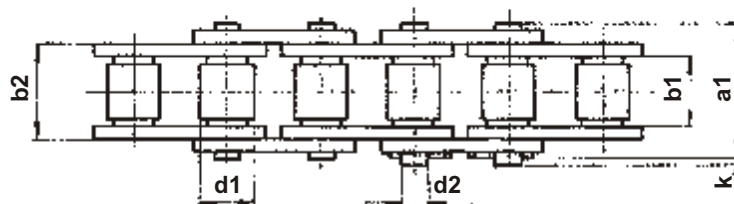
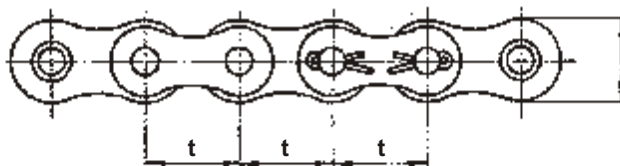

lanac broj chain number	korak pitch		unutrašnja širina between inner plates	prečnik valjka roller diametar	širina unutra. članka inner link track	prečnik svornjaka pin diametar	širina lamele plate track	širina lanca chain track	dodatak appendix	sila kidanja breaking load	težina weight
	ISO	t									
06 B-1	9,525	3/8	5,72	6,35	8,53	3,31	8,5	13,5	3,3	9	0,41
081	12,7	1/2	3,3	7,75	5,8	3,59	9,9	10,2	1,5	8,2	0,28
082	12,7	1/2	2,38	7,75	4,6	3,59	9,9	8,6	-	10	0,26
083	12,7	1/2	4,88	7,75	7,9	4,09	10,3	12,9	1,5	12	0,42
084	12,7	1/2	4,88	7,75	8,8	4,09	11,1	14,8	1,5	16	0,59
08 B-1	12,7	1/2	7,55	8,51	11,3	4,45	12	17	3,9	18	0,7
10 B-1	15,875	5/8	9,65	10,16	13,28	5,08	14,7	19,6	4,1	22,4	0,95
12 B-1	19,05	3/4	11,68	12,07	15,62	5,72	16,2	22,7	4,6	29	1,25
16 B-1	25,4	1	17,02	15,88	25,4	8,28	21	36,1	5,4	60	2,7
20 B-1	31,75	1 1/4	19,56	19,05	29	10,19	26,4	43,2	6,1	95	3,6
24 B-1	38,1	1 1/2	25,4	25,4	37,9	14,63	33,4	53,4	6,6	160	6,7
28 B-1	44,45	1 3/4	30,99	27,94	46,5	15,9	37	65,1	7,4	200	8,3
32 B-1	50,8	2	30,99	29,21	45,5	17,81	42,2	67,4	7,9	250	10,5
40 B-1	63,5	2 1/2	38,1	39,37	55,7	22,89	52,9	82,6	10,2	355	16
48 B-1	76,2	3	45,72	48,26	70,5	29,24	63,8	99,1	10,5	560	25
56 B-1	88,9	3 1/2	53,34	53,98	81,3	34,32	77,8	114,6	11,7	850	35
64 B-1	101,6	4	60,96	63,5	92	39,4	90,1	130,9	13	1120	60
72 B-1	114,3	4 1/2	68,58	72,39	103,8	44,5	103,6	147,4	14,3	1400	80

VALJKASTI LANCI, EVROPSKI STANDARD

ROLLING CHAINS, EUROPEAN STANDARD

ISO 606 - 1982 (DIN8187) DVOREDNI

REZERVNI SPOJNI ELEMENTI / SPARE PARTS

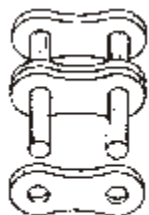

No.108
SPOLJNI ČLANAK
OUTER LINK



No.28
ČLANAK ZA
VEZU PRAV
CONNECTING LINK

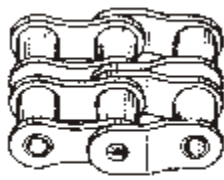

No.32
DUPLI KRIVI ČLANAK
CRANKED LINK DOUBLE

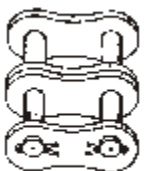

No.68
ČLANAK
ZA VEZU PRAV
CONNECTING LINK



No.114
KRIVI ČLANAK
ZA VEZU
CRANKED LINK

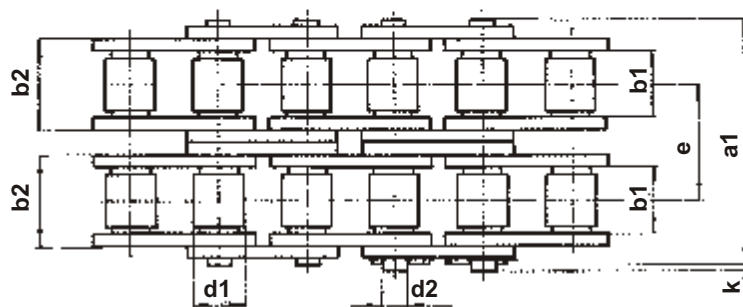
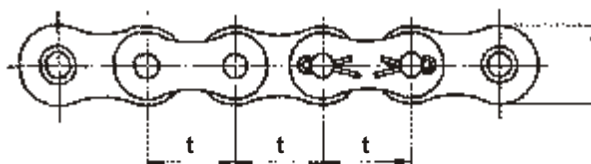

lanac broj chain number	korak pitch		unutrašnja širina between inner plates	prečnik valjka roller diametar	širina unutra. članka inner link track	prečnik svornjaka pin diametar	širina lamele plate track	širina lanca chain track	dodatak appendix	korak po širini pitch width	sila kidanja breaking load	težina weight
	t											
ISO	mm	inch/zoll	b1 min	d1 max	b2 max	d2 h9	g max	a1 max	k max	e	kN min	g kg/m
06 B-2	9,525	3/8	5,72	6,35	8,53	3,31	8,5	23,8	3,3	10,24	16	0,78
08 B-2	12,7	1/2	7,75	8,51	11,3	4,45	12	31	3,9	13,92	32	1,35
10 B-2	15,875	5/8	9,65	10,16	13,28	5,08	14,7	36,2	4,1	16,59	40	1,85
12 B-2	19,05	3/4	11,68	12,07	15,62	5,72	16,2 ^{+0,2}	42,2	4,6	19,46	53	2,5
16 B-2	25,4	1	17,02	15,88	25,45	8,28	21	68	5,4	31,88	106	5,4
20 B-2	31,75	1 1/4	19,56	19,05	29,01	10,19	26,4	79,7	6,1	36,45	170	7,2
24 B-2	38,1	1 1/2	25,4	25,4	37,92	14,63	33,4	101,8	6,6	48,36	280	13,5
28 B-2	44,45	1 3/4	30,99	27,94	46,58	15,90	37	124,7	7,4	59,56	360	16,6
32 B-2	50,8	2	30,99	29,21	45,57	17,81	42,2	126	7,9	58,55	450	21
40 B-2	63,5	2 1/2	38,1	39,37	55,75	22,89	52,9	154,9	10,2	72,29	630	32
48 B-2	76,2	3	45,72	48,26	70,56	29,24	63,8	190,4	10,5	91,21	1000	50
56 B-2	88,9	3 1/2	53,34	53,98	81,3	34,32	77,8	221,2	11,7	106,6	1600	70
64 B-2	101,6	4	60,96	63,5	92	39,4	90,1	250,8	13	119,89	2000	120
72 B-2	114,3	4 1/2	68,58	72,39	103,8	44,5	103,6	283,7	14,3	136,27	2500	160

VALJKASTI LANCI, EVROPSKI STANDARD

ROLLING CHAINS, EUROPEAN STANDARD

ISO 606 - 1982 (DIN8187) TROREDNI

REZERVNI SPOJNI ELEMENTI / SPARE PARTS



No.108
SPOLJNI ČLANAK
OUTER LINK



No.28
ČLANAK ZA VEZU PRAV
CONNECTING LINK

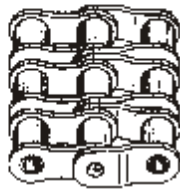

No.32
DUPLI KRIVI ČLANAK
CRANKED LINK DOUBLE

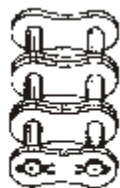

No.68
ČLANAK ZA VEZU PRAV
CONNECTING LINK



No.114
KRIVI ČLANAK ZA VEZU
CRANKED LINK

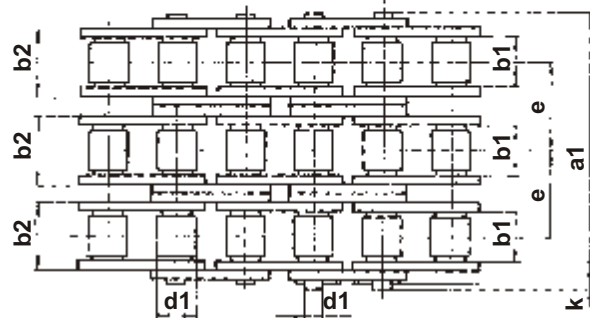
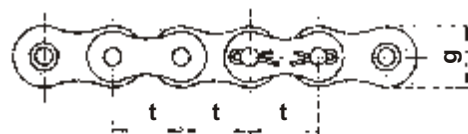

lanac broj chain number	korak pitch		unutrašnja širina between inner plates	prečnik valjka roller diameter	širina unutra- članka inner link track	prečnik svornjaka pin diameter	širina lamele plate track	širina lanca chain track	dodatak appendix	korak po širini pitch width	sila kidanja breaking load	težina weight
	mm	inch/zoll										
ISO	t		b1 min	d1 max	b2 max	d2 h9	g max	a1 max	k max	e	kN min	g kg/m
	mm	inch/zoll										
06 B - 3	9,525	3/8	5,72	6,35	8,53	3,31	8,5	34	3,3	10,24	23,6	1,18
08 B - 3	12,7	1/2	7,75	8,51	11,3	4,45	12	44,9	3,9	13,92	47,5	2
10 B - 3	15,875	5/8	9,65	10,16	13,28	5,08	14,7	52,8	4,1	16,59	60	2,8
12 B - 3	19,05	3/4	11,68	12,07	15,62	5,72	16,2	61,7	4,6	19,46	80	3,8
16 B - 3	25,4	1	17,02	15,88	25,45	8,28	21	99,99	5,4	31,88	160	8
20 B - 3	31,75	1 1/4	19,56	19,05	29,01	10,19	26,4	116,1	6,1	36,45	250	11
24 B - 3	38,1	1 1/2	25,4	25,4	37,95	14,63	33,4	150,2	6,6	48,36	425	21
28 B - 3	44,45	1 3/4	30,99	27,94	46,58	15,90	37	184,3	7,4	59,56	530	25
32 B - 3	50,8	2	30,99	29,21	45,57	17,81	42,20	184,5	7,9	58,55	670	32
40 B - 3	63,5	2 1/2	38,1	39,37	55,75	22,89	52,9	227,2	10,2	72,29	950	48
48 B - 3	76,2	3	45,72	48,26	70,56	29,24	63,8	281,6	10,5	91,21	1050	75
56 B - 3	88,9	3 1/2	53,34	53,98	81,3	34,32	77,8	-	11,7	106,6	2240	105
64 B - 3	101,6	4	60,96	63,50	92	39,4	90,1	-	13	119,89	3000	180
72 B - 3	114,3	4 1/2	68,58	72,39	103,8	44,5	103,6	-	14,3	136,27	3750	240

VALJKASTI LANCI, AMERIČKI STANDARD

ROLLING CHAINS, AMERICAN STANDARD

ANSI B 29.1-1975-ISO 606-1982 (DIN 8188) JEDNOREDNI

REZERVNI SPOJNI ELEMENTI / SPARE PARTS



No.3
UNUTRAŠNJI ČLANAK
INNER LINK



No.108
SPOLJNI ČLANAK
OUTER LINK

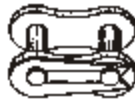

No.28
ČLANAK ZA VEZU PRAV
CONNECTING LINK

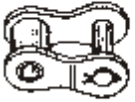

No.114
KRIVI ČLANAK
ZA VEZU
CRANKED LINK

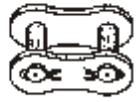

No.68
ČLANAK ZA VEZU
PRAV
CONNECTING LINK



No.32
DUPLI KRIVI ČLANAK
CRANKED LINK DOUBLE



No.23
SPOJNA OPRUGA
SPRING CLIP FASTENER

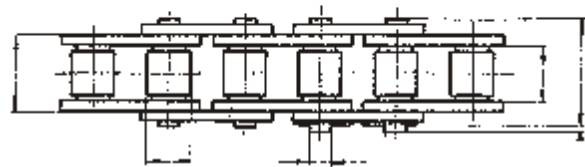
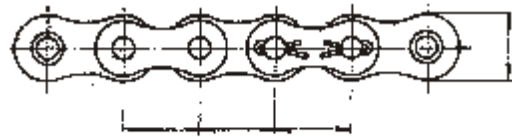

lanac broj chain number	korak pitch		unutrašnja širina between inner plates	prečnik valjka roller diametar	širina unutra. članka inner link track	prečnik svornjaka pin diametar	širina lamele plate track	širina lanca chain track	dodatak appendix	sila kidanja breaking load	težina weight
	t										
ISO	mm	inch/zoll	b1 min	d1 max	b2 max	d2 h9	g max	a1 max	k max	kN min	g kg/m
06 C	9,525	3/8	4,77	5,08	7,47	3,58	9,05	11,9	1	8	0,31
08 A	12,7	1/2	7,95	7,92	11,18	3,96	12,07	17,8	3,9	14,1	0,61
085	12,7	1/2	6,36	7,77	9,07	3,58	9,91	14	2	8	0,38
10 A	15,875	5/8	9,53	10,16	13,84	5,08	15,09	21,8	4,1	22,0	1,01
12 A	19,05	3/4	12,7	11,91	17,75	5,94	18,08	26,9	4,6	31,8	1,58
16 A	25,4	1	15,88	15,88	22,61	7,92	24,13	33,5	5,4	56,7	2,36
20 A	31,75	1 1/4	19,05	19,05	27,46	9,5	30,18	41,1	6,1	88,5	3,80
24 A	38,1	1 1/2	25,4	22,23	35,46	11,10	36,20	50,8	6,6	127	5,40
28 A	44,45	1 3/4	25,4	25,4	37,19	12,70	42,24	54,9	7,4	172,4	7,30
32 A	50,8	2	31,75	28,57	45,21	14,27	48,26	65,5	7,9	226,8	9,90
-	57,15	2 1/4	35,71	35,71	50,00	17,4	52,00	70,6	6,9	281,6	13,20
40 A	63,5	2 1/2	38,1	39,67	54,89	19,84	60,33	80,3	10,2	347	16,50
48 A	76,2	3	47,63	47,62	67,89	23,80	72,39	95,5	10,5	500,4	22,60

VALJKASTI LANCI, AMERIČKI STANDARD

ROLLING CHAINS, AMERICAN STANDARD

ANSI B 29.1-1975-ISO 606-1982 (DIN 8188) DVOREDNI

REZERVNI SPOJNI ELEMENTI / SPARE PARTS

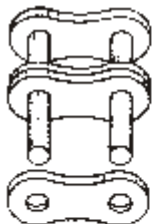

No.108
SPOLJNI ČLANAK
OUTER LINK

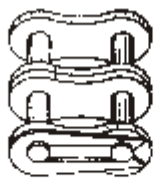

No.28
ČLANAK ZA VEZU PRAV
CONNECTING LINK



No.32
DUPLI KRIVI ČLANAK
CRANKED LINK DOUBLE

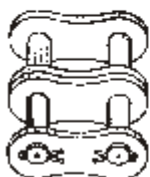

No.68
ČLANAK
ZA VEZU PRAV
CONNECTING LINK

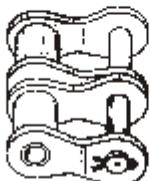

No.114
KRIVI ČLANAK
ZA VEZU
CRANKED LINK

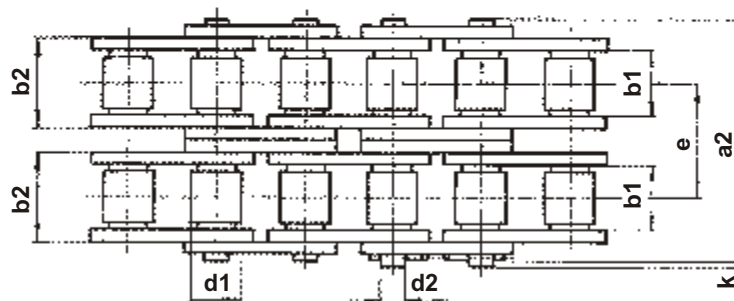
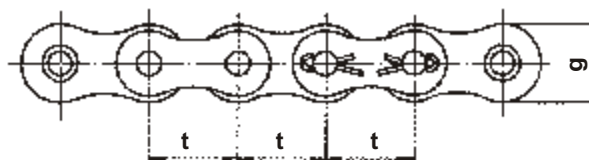

lanac broj chain number	korak pitch		unutrašnja širina between inner plates	prečnik valjka roller diameter	širina unutra. članka inner link track	prečnik svornjaka pin diameter	širina lemele plate track	širina lanca chain track	dodatak appendix	korak po širini pitch width	silna kidanja breaking load	težina weight
ISO	t		b1 min	d1 max	b2 max	d2 h9	g max	a1 max	k max	e2	kN min	g kg/m
	mm	inch/zoll										
06 C-2	9,525	3/8	4,77	5,08	7,47	3,58	9,00	22,5	1	10,13	16	0,67
08 A-2	12,7	1/2	7,95	7,92	11,18	3,96	12,07	32,3	3,9	14,38	28,2	1,19
10 A-2	15,875	5/8	9,53	10,16	13,84	5,08	15,09	39,9	4,1	18,11	44,4	1,70
12 A-2	19,05	3/4	12,7	11,91	17,75	5,94	18,08	49,8	4,6	22,78	63,6	3,14
16 A-2	25,4	1	15,88	15,88	22,61	7,92	24,13	62,7	5,4	29,29	113,4	4,90
20 A-2	31,75	1 1/4	19,05	19,05	27,46	9,5	30,18	77	6,1	35,76	177	7,60
24 A-2	38,1	1 1/2	25,4	22,23	35,46	11,10	36,20	96,3	6,6	45,44	254	10,80
28 A-2	44,45	1 3/4	25,4	25,4	37,19	12,70	42,24	103	7,4	48,87	344,8	14,30
32 A-2	50,8	2	31,75	28,57	45,21	14,27	48,26	124	7,9	58,55	453,6	19,40
-	57,15	2 1/4	35,71	35,71	50,00	17,4	52,00	136,6	6,9	65,84	563,2	26,00
40 A-2	63,5	2 1/2	38,1	39,67	54,89	19,84	60,33	151	10	71,55	707,6	33,00
48 A-2	76,2	3	47,63	47,62	67,89	23,80	72,39	183	10	87,83	1020,6	44,00

VALJKASTI LANCI, AMERIČKI STANDARD

ROLLING CHAINS, AMERICAN STANDARD

ANSI B 29.1-1975-ISO 606-1982 (DIN 8188) TROREDNI

REZERVNI SPOJNI ELEMENTI / SPARE PARTS



No.108
SPOJNI ČLANAK
OUTER LINK



No.28
ČLANAK ZA VEZU PRAV
CONNECTING LINK



No.32
DUPLI KRIVI ČLANAK
CRANKED LINK DOUBLE



No.68
ČLANAK ZA VEZU PRAV
CONNECTING LINK



No.114
KRIVI ČLANAK ZA VEZU
CRANKED LINK

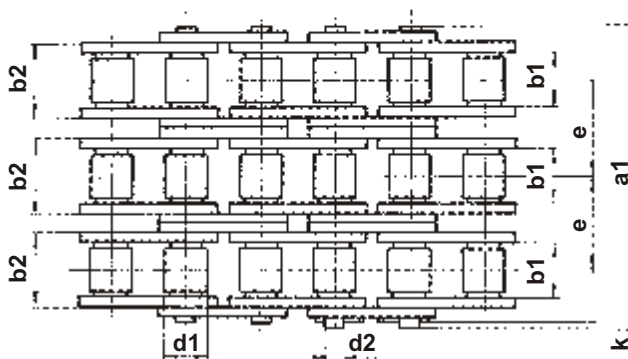
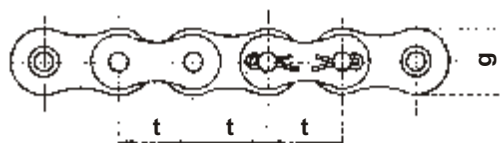

lanac broj chain number	korak pitch		unutrašnja širina between inner plates	prečnik valjka roller diameter	širina unutra. članka inner link track	prečnik svornjaka pin diameter	širina lamele plate track	širina lanca chain track	dodatak appendix	korak po širini pitch width	sila kidanja breaking load	težina weight
	mm	inch/zoll										
ISO	t		b1	d1	b2	d2	g	a1	k	e2	kN	g
	mm	inch/zoll	min	max	max	h9	max	max	max		min	kg/m
06 C-3	9,525	3/8	4,77	5,08	7,47	3,58	9,00	33,1	1	10,13	24	1,01
08 A-3	12,7	1/2	7,95	7,92	11,18	3,96	12,07	46,7	3,9	14,38	42,3	1,78
10 A-3	15,875	5/8	9,53	10,16	13,84	5,08	15,09	57,9	4,1	18,11	66,6	3,02
12 A-3	19,05	3/4	12,7	11,91	17,75	5,94	18,08	72,6	4,6	22,78	95,4	4,70
16 A-3	25,4	1	15,88	15,88	22,61	7,92	24,13	91,7	5,4	29,29	170,1	7,50
20 A-3	31,75	1 1/4	19,05	19,05	27,46	9,5	30,18	113	6,1	35,76	265,5	11,20
24 A-3	38,1	1 1/2	25,4	22,23	35,46	11,10	36,20	141,7	6,6	45,44	381	16,10
28 A-3	44,45	1 3/4	25,4	25,4	37,19	12,70	42,24	152	7,4	48,87	517,2	21,40
32 A-3	50,8	2	31,75	28,57	45,21	14,27	48,26	182	7,9	58,55	680,4	29,10
-	57,15	2 1/4	35,71	35,71	50,00	17,4	52,00	202,4	6,9	65,84	844,8	38,60
40 A-3	63,5	2 1/2	38,1	39,67	54,89	19,84	60,33	223	10	71,55	1061,4	50,00
48 A-3	76,2	3	47,63	47,62	67,89	23,80	72,39	271	10	87,83	1530,9	66,00

VALJKASTI LANCI SA DUGIM ČLANKOM

ROLLER CHAINS DOUBLE PITCH

ISO 1275-1972 (DIN 8188 I ANSI)



No.3

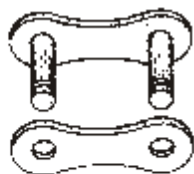

No.108



No.68



No.114

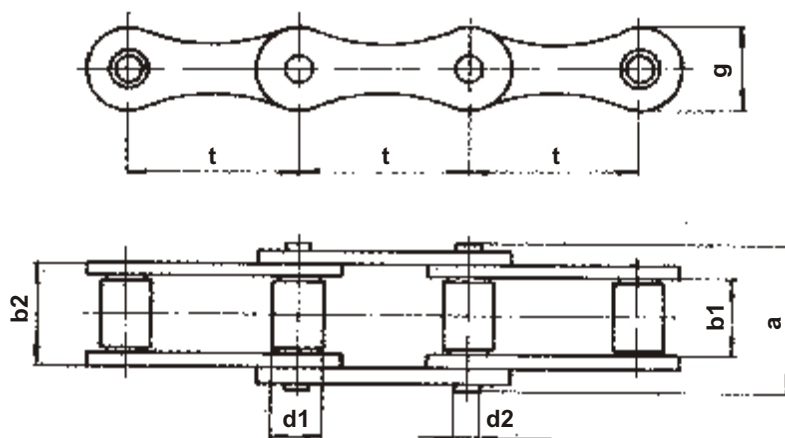

lanac broj chain number	korak pitch		unutrašnja širina between inner plates	prečnik valjka roller diameter	širina unutra. članka inner link track	prečnik svornjaka pin diameter	širina lamele plate track	širina lanca chain track	silna kidanja breaking load	težina weight
ISO	t		b1 min	d1 max	b2 max	d2 h9	g max	a1 max	kN min	g kg/m
	mm	inch/zoll								
208 B	25,4	1	7,75	8,51	11,30	4,45	11,8	17,0	18	0,45
210 B	31,75	1 1/4	9,65	10,16	13,28	5,08	14,2	19,6	22,4	0,65
212 B	38,1	1 1/2	11,68	12,07	15,62	5,72	16,1	22,7	29	0,76
216 B	50,8	2	17,02	15,88	25,45	8,28	21	36,1	60	1,75
220 B	63,5	2 1/2	19,56	19,05	29,01	10,19	26,4	43,2	95	1,95
224 B	76,2	3	25,4	25,4	37,92	14,63	33,4	53,4	160	4,5
208 A	25,4	1	7,95	7,92	11,15	3,96	12	17,8	14,1	0,42
210 A	31,75	1 1/4	9,53	10,16	13,8	5,08	15	21,8	22,2	0,7
212 A	38,1	1 1/2	12,7	11,91	17,7	5,94	18	26,9	31,8	1
216 A	50,8	2	15,88	15,88	22,5	7,92	24,1	33,5	56,7	1,7
220 A	63,5	2 1/2	19,05	19,05	27,4	9,53	30,1	41,1	88,5	2,55
224 A	76,2	3	25,4	22,23	35,6	11,1	36,2	50,8	127	3,5

VALJKASTI LANCI, OJAČANI

ROLLER CHAINS, HEAVY SERIES

ANSI B 29,1 1975

lanac broj chain number	korak pitch		unutrašnja širina between inner plates	prečnik valjka roller diameter	širina unutra. članka inner link track	prečnik svornjaka pin diameter	širina lamele plate track	širina lanca chain track	sila kidanja breaking load	težina weight
	t									
	mm	inch/zoll								
60 H	19,05	3/4	12,7	11,91	19,43	5,94	17,5	30,9	31,8	1,7
80 H	25,4	1	15,88	15,88	24,28	7,92	24	39	56,7	2,98
100 H	31,75	1 1/4	19,05	19,05	29,06	9,55	29,5	47,2	100	4,35
140 H	44,45	1 3/4	25,4	25,4	38,79	12,7	38	62	200	8,2
C2060	38,1	1 1/2	12,7	12,7	19,43	5,94	17	30,7	31,8	1,5

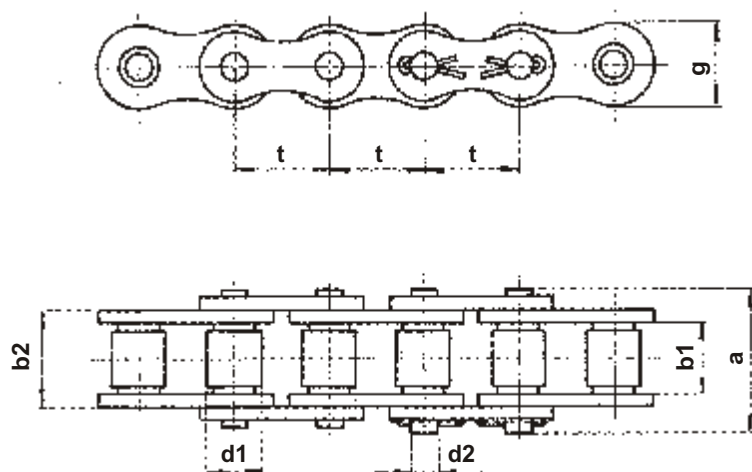

VALJKASTI LANCI, FABRIČKI STANDARD

ROLLER CHAINS, FACTORY STANDARD

lanac broj chain number	korak pitch		unutrašnja širina between inner plates	prečnik valjka roller diameter	širina unutra. članka inner link track	prečnik svornjaka pin diameter	širina lamele plate track	širina lanca chain track	sila kidanja breaking load	težina weight
	t									
	mm	inch/zoll								
175	12,7	1/2	5,2	7,75	8,45	4,09	11,15	14,8	16	0,60
180	12,7	1/2	5,2	8,51	8,73	4,45	12,2	15,3	18	0,62
185	12,7	1/2	6,4	8,51	9,93	4,45	12,2	16,5	18	0,66
215	15,875	5/8	6,48	10,16	10,08	5,08	14,5	17,5	22,4	0,78
301	25,4	1	12,7	15,88	21,13	8,28	21,1	33,5	60	2,50
320	30	-	17,02	15,88	25,45	8,28	21,1	38,8	60	2,70
365	38,1	1 1/2	22,1	21,6	31,60	12,00	33,40	44,6	120	4,00

ČAURASTI LANCI

BUSH CHAINS

DIN 8164

lanac broj chain number	korak pitch	unutrašnja širina between inner plates	prečnik čaure bush diameter	prečnik osovine axle diameter	dužina osovine za vezu	dužina osovine axle length	širina lamele plate track	širina unutra. članka inner link track	debljina lamele plate thickness	zglobna površina	sila kidanja breaking load	težina weight
	t mm	b1 min	d	d1 max	e ± 1	e1 ± 1	g	b2 max	S	A (b2 x d1) cm ²	kN	g kg/m
1015	15	14	9	6	33	27	14	18,5	2	1,1	12,5	1,20
1020	20	16	12	8	39	34	19	22,5	3	1,8	25	2,10
1025	25	18	15	10	44	37	24	24,5	3	2,5	31,5	2,60
1030	30	20	17	11	50	44	28	28,5	4	3,1	40	4,00
1035	35	22	18	12	55	46	30	30,5	4	3,7	50	4,30
1040	40	25	20	14	62	53	35	35,5	5	5,0	60	6,00
1045	45	30	22	16	72	63	40	42,5	6	6,8	80	8,00
1050	50	35	26	18	80	68	44	47,5	6	8,6	100	9,00
1055	55	45	30	20	100	86	49	61,5	8	12,3	125	14,00
1060	60	50	32	22	105	92	55	66,5	8	14,6	160	15,00
1065	65	55	36	26	114	98	61	72	8	18,7	200	19,00
1070	70	65	42	30	133	117	67	86	10	28,8	250	25,00
1080	80	70	44	32	151	131	75	96	12	30,7	315	31,00
1090	90	80	50	36	161	141	85	106	12	38,2	400	42,00
1100	100	90	56	42	173	153	95	116	12	48,7	500	49,00

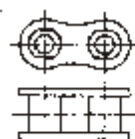

No.3

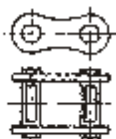

No.108

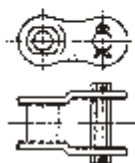

No.114

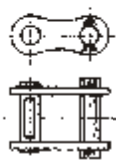

No.68

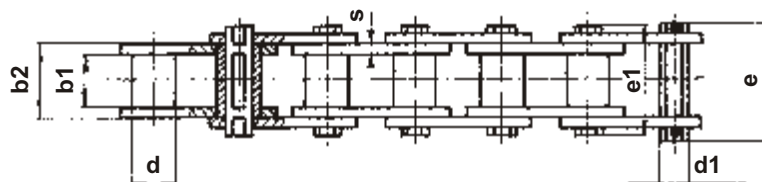
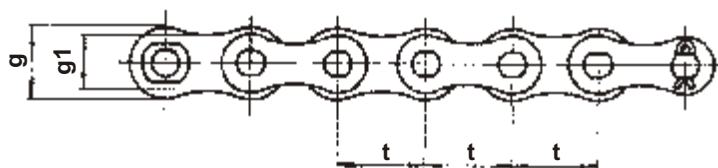

ČAURASTI LANCI PO FABRIČKOM STANDARDU

BUSH CHAINS - FACTORY STANDARD

lanac broj chain number	korak pitch	unutrašnja širina between inner plates	prečnik čaure bush diameter	prečnik osovine axle diameter	dužina osovine za vezu	dužina osovine axle length	širina lamele plate track	širina unutra. članka inner link track	debljina lamele plate thickness	zglobna površina	sila kidanja breaking load	težina weight
	t mm	b1 min	d	d1 max	e ± 1	e1 ± 1	g	b2 max	S	A (b2 x d1) cm ²	kN	g kg/m
1051	50	25	22	16	61	56,4	42	37	6	5,47	80	8,9
1061	58,62	30	22	14	77	69	36	46	8	6,44	80	13,7

GALOVI LANCI

GALL CHAINS

DIN 8150

lanac broj chain number	t mm	b1 min	d1 h11	d2 c11h11	d3	g1	g2	e1	e2	S	L	broj lamela plate number	zglobna površina A cm ² z x s x d2	kN min	g Kp/m	e
2015	15	12	5	4,0	9	12	18	27	25	2,0	20	2	0,16	0,5	0,700	-
2020	20	15	8	6,0	10	15	20	33	28	2,0	25	2	0,24	1,25	1,10	-
2025	25	18	10	8,0	12	18	25	42	36	3,0	30	2	0,48	2,5	1,8	67
2030	30	20	11	9,0	14	20	30	58	51	3,0	40	4	1,08	4	3,40	87
2035	35	22	12	10	16	26	35	64	53	3,0	45	4	1,20	6	4,50	92
2040	40	25	14	12	18	30	40	66	58	3,0	50	4	1,44	8	5,0	101
2045	45	30	17	14	22	35	45	70	63	3,0	55	4	1,68	10	7,0	107
2050	50	35	22	18	26	38	50	97	90	4,5	60	4	3,24	15	11,3	140
2055*	55	40	24	21	32	40	55	115	108	6,0	65	4	5,04	20	14,5	162
2060*	60	45	26	23	36	45	60	120	114	6,0	70	4	5,52	25	17,1	170
2070*	70	50	32	28	41	55	70	157	148	6,0	85	6	10,18	37,5	34,0	210
2080*	80	60	36	32	50	60	85	171	159	6,0	100	6	11,52	50	39,0	232
2090*	90	70	40	36	60	70	100	200	184	7,0	120	6	15,12	75	53,0	265
2100*	100	80	45	40	70	80	120	234	224	7,0	140	8	22,95	100	77,0	308
2110*	110	90	50	45	80	90	140	251	236	7,0	160	8	25,28	125	90,0	326
2120*	120	100	60	50	90	100	160	277	262	8,0	180	8	32,00	150	112	356

* Proizvode se isključivo sa ravnim lamelama

* Straight side plates only

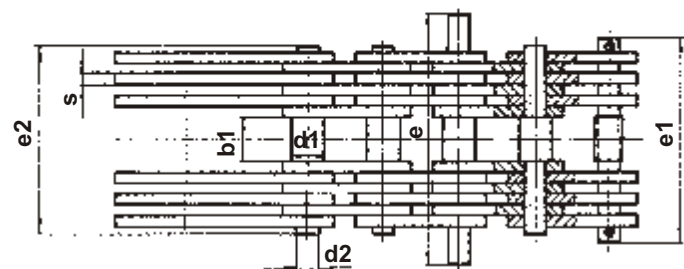
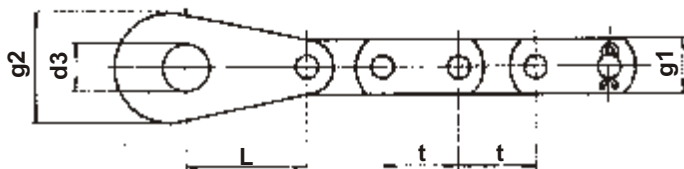
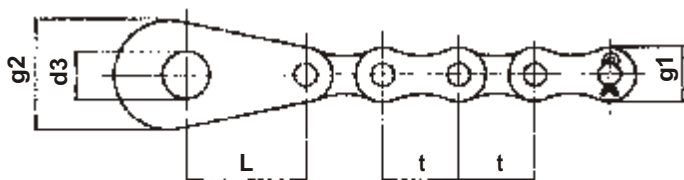

ESKAVATORSKI LANCI

ROTARY CHAINS

A.P.I. DIN 8182 - ISO 3512-1976 i FABRIČKOM STANDARDU / AND FACTORY STANDARD

lanac broj chain number	korak pitch		unutrašnja širina between inner plates	prečnik valjka roller diameter	dimenzije članaka anckles dimension		prečnik čaure bush diameter	prečnik svornjaka pin diameter	širina lanca chain track	širina lamele plate track	debljina lamele plate thickness	sila kidanja breaking load	težina weight
	t				b1 min	b2 max							
	mm	inch/zoll	d1 max	d2 mm			d2 h9	a1 max	g max	S max	kN min	q kg/m	
4150	77,9	3,067	39,7	41,28	59,0	60,0	29,00	19,05	97,5	60,00	9	453	18,2
4200	78,105	3,075	38,1	31,75	59,5	60,5	25,00	17,00	98,0	45,0	10	365	11,2
4201	78,105	3,075	38,1	35	59,5	60,5	25,00	17,00	98,0	45,0	10	365	12,3
A.P.I.3 4202	78,105	3,075	39,2	31,75	57,6	60,1	23,10	16,50	95,0	45,0	9	340	11,5
4250	79,375	3,125	40,7	41,27	59,9	61,0	29,00	20,00	98,0	60,0	9	500	16,4
A.P.I.4 4300	103,2	4,063	49,2	44,45	77,9	78,4	31,75	22,16	127,0	58,5	13	680	20,9
4301	103,2	4,063	49,2	46	88,8	84,0	32,00	23,70	140,0	60,0	16	750	34,2
4302	103,2	4,063	49,2	46	78,6	79,6	32,00	23,70	130,0	60,0	14	640	19,5
4303	103,2	4,063	50,4	56	80	82	38	30	135	70	14	800	39,5
4350	127,0	5,0	68,2	63,5	99,5	102,0	43,00	31,75	160,0	90,0	15	1300	44,4
4351	127,0	5,0	59	63,5	90,3	92,8	43,00	31,75	150,8	90,0	15	1300	52,0
4352	127,0	5,0	69,8	63,5	102,4	104,0	43,00	31,75	162	90,0	15	1300	52,0

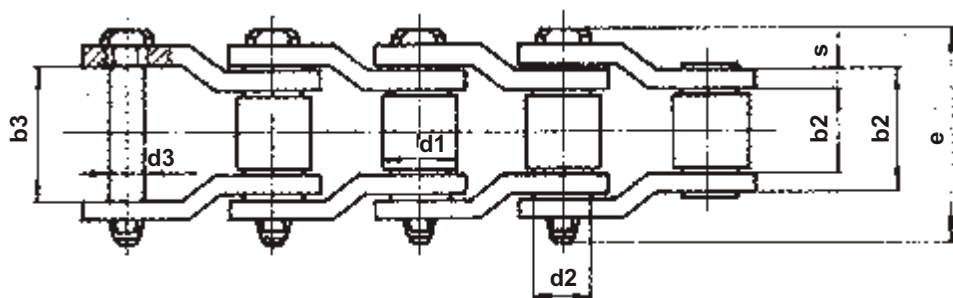

LANCI SA ŠUPLJIM OSOVINAMA

HOLLOW PINS CHAINS

FABRIČKI STANDARD / FACTORY STANDARD

lanac broj chain number	korak pitch	unutrašnja širina between inner plates	prečnik valjka roller diameter	prečnik čaure bush diameter	prečnik šuplje osovine hollow pins diameter	unutrašnji prečnik šuplje osovine inside diameter of hollow pin	širina lamele plate track	debljina lamele plate thickness	dužina osovine axle lenght	dužina osovine za vezu	sila kidanja breaking load	težina weight
	t mm	b min	d2 mm	d5 mm	d6 mm	d7 mm	g	S	F1 mm	F1 mm	kN	kg/m
411967	38,1	15	25,4	17,8	13,8	10,1	30	4	35,5	-	42	3,8
310376	41,4	15	25,4	17,8	13,8	10,5	32	4	35,5	41,3	39	3,5
308975	50	15	32	17,8	13,8	10,1	25	4	35,5	41,3	42	3,9
408600	50,8	10	30	16	11,5	8,2	24	3,2	27	30	32	2,1
416097	50,8	10	35	16	11,5	8,2	24	3,2	27	-	30	2,9
316776	50,8	20	32	23,6	19,1	12,4	40	4 i 5	44,6	-	55	5,8
310356	60	15	32	17,8	13,8	10,5	26	4	35,5	41,3	28	3,5
316100	100	10	30-1	16	11,5	8,2	26	3,2	27	30	30	1,5
309070	100	15	32	17,8	13,8	10,1	26	4	35,5	41,3	42	2,9

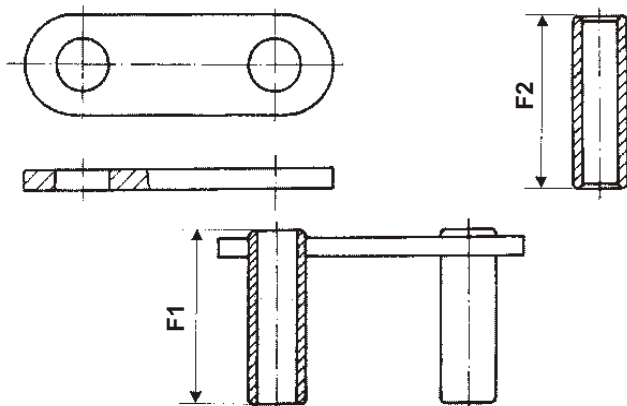
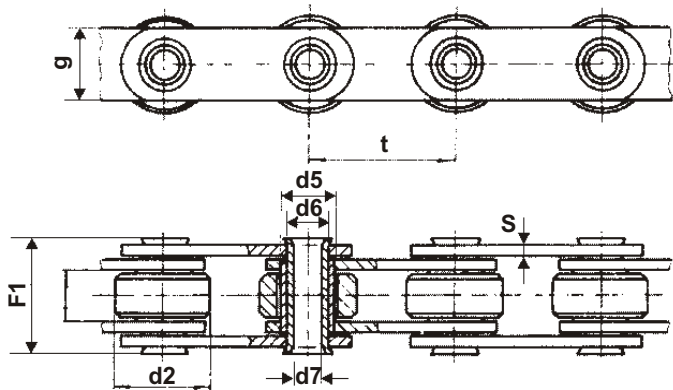

PLOČASTI LANCI - TEŠKA IZVEDBA

LEAF CHAINS - LIGHT

ISO 4347 - 1977 (DIN 8152 - DEO / PART 1)

lanac broj chain number	korak pitch		d1 min	g max	S	d2 max	kombinacija / combination									
							2 x 3			3 x 4			4 x 6			
							a1 max	prek.sila	težina	a2 max	prek.sila	težina	a3 max	prek.sila	težina	
DIN	t		mm	mm	mm	mm	mm	kN min	kg/m	mm	kN min	kg/m	mm	kN min	kg/m	
	mm	inch/zoll														
LH 08	12,7	1/2	5,12	11,2	2	5,09	13	22,2	0,8	17,4	33,3	1,1	23,8	44,4	1,6	
LH 10	15,875	5/8	5,98	14,2	2,4	5,94	15,3	32,6	1,1	20,3	48,9	1,5	27,7	65,2	2,1	
LH 12	19,05	3/4	7,96	16,2	3,2	7,92	20,7	48,9	1,8	27,4	73,4	2,5	37,4	97,8	3,6	
LH 16	25,4	1	9,63	24	4	9,53	25,4	84,5	2,7	33,7	126,7	3,8	46,1	169	5,4	
LH 20	31,75	1 1/4	11,19	26,2	4,6	11,10	30,3	115,7	4,3	40,2	173,6	5,9	55	231,4	8,4	
LH 24	38,1	1 1/2	12,74	35	5,5	12,7	35,4	151,2	5,8	47	226,8	8,1	64,5	302,6	11,5	
LH 28	44,45	1 3/4	14,33	38	6,3	14,27	40,1	191,3	7,6	53,3	286,9	10,6	73,1	382,6	15	
LH 32	50,8	2	17,51	44	7	17,45	46,5	289,1	10	61,7	433,6	14	84,4	578,2	20	

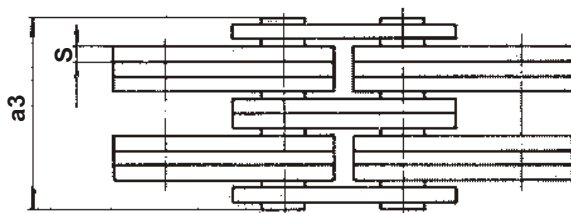
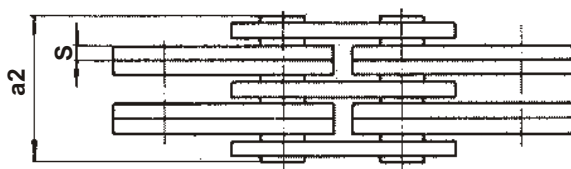
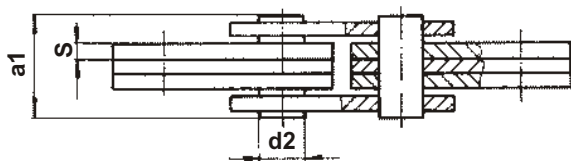
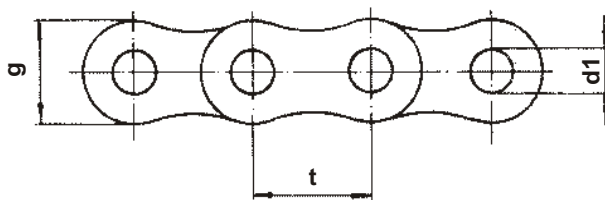

LANCI ZA VODENE BRANE

CHAINS FOR WATER BARRIERS

lanac broj chain number	korak pitch	unutrašnja širina between inner plates	prečnik svornjaka pin diameter	prečnik čaure bush diameter	dimenzija svornjaka dimensions of pin			širina lamele plate track	debljina lamele size of link plate	dimenzija produženih članaka dimension of end attachment link				radno i prekidno opterećenje work's and break's load		težina weight
					a	e1	e2			d2	g2	l1	l2	kN	kN	
4000	100	25	25	40	20	147	187	50	8	40	70	40	140	100	480	26
4010	100	25	28	40	25	157	207	60	8	45	75	45	140	120	600	30
4030	125	30	30	45	30	188	248	60	10	50	90	50	175	150	720	35
4040	150	40	35	50	35	225	295	70	12	60	100	55	200	200	1000	50
4050	170	50	40	60	40	272	352	80	15	70	120	65	225	300	1440	80
4060	180	50	50	70	40	272	352	100	15	80	140	80	225	400	1800	110
4070	200	60	60	80	50	303	403	120	15	90	160	90	275	500	2150	155
4080	250	70	70	95	55	368	478	140	20	100	180	100	325	750	3350	190
4090	300	80	80	110	60	436	556	150	25	120	210	115	400	1000	4200	250
4100	350	100	90	120	60	540	660	170	35	140	240	130	450	1500	6500	380

